

**INSTALLATION
GUIDE**
(Lay-in System)

INSTALLING DONN® BRAND ACOUSTICAL SUSPENSION SYSTEM

The original and most widely used acoustical suspension system.

CONFIDENCE WITH A CLICK

CHOOSING THE BEST CEILING FOR YOUR PROJECT CAN MAKE ALL THE DIFFERENCE.

For over 50 years, USG ME Donn® Brand has led the industry with innovations that make suspension systems easier, faster, and more reliable to install.

With an unparalleled variety of choices, no matter what your ceiling needs, we have you covered.

1. PRODUCTIVITY

Tight, reliable connections with low insertion force are the hallmark of USG ME Donn® Brand Acoustical Suspension Systems. The main tee and cross tee clips are removable without tools— making layout changes quicker—and The Donn Click™ audible cross tee sound lets you know when the tee is engaged. Precise dimensional tolerances prevent the modules from distorting and help keep the system square. All of this adds up to easier and faster installation.

2. FULL PRODUCT PORTFOLIO

USG Middle East offers a full line of ceilings suspension system styles and functionality. With nine different profiles to choose from, USG ME has the look design professionals want. USG Donn® is the global most recognized ceilings suspension system. USG ME Logix™ systems are-designed for layouts that integrate modern, linear lighting designs.

3. CODE COMPLIANCE

All USG ME Donn® Brand Acoustical Suspension Systems have been thoroughly tested and comply with all industrial related international standards and Saudi building code jurisdictions, including seismic category C, and D-F. our Donn® Brand Acoustical Suspension Systems are exceeds load compliance specifications as per ASTM C 635.

4. CUSTOM OPTIONS

USG offers suspension systems in different colors, including widen finish. USG ME also has the ability to create suspension system components for custom installations with nonstandard module sizes.

INSTALLING DONN® BRAND ACOUSTICAL SUSPENSION SYSTEM

LAY-IN

The appearance of a suspended acoustical ceiling is dependent both on the materials used and on the quality of the installation. USG ME manufactures components to meet ASTM C636, 2006 IBC (2007 CBC), Cisca Ceiling Systems Handbook, (UL Design) and any applicable code requirement, assuring that the material, structural and quality standards are as prescribed. Install according to ASTM C636, ASTM E580 and USG requirements, assuring proper level and secure attachment as prescribed. Good construction conditions are very important when successfully installing a suspended ceiling. It is recommended that the temperature and humidity range be 14 - 25°C and max. 75% relative humidity. Store materials in a protected area, store tiles on the job at least 3 days prior to installation.

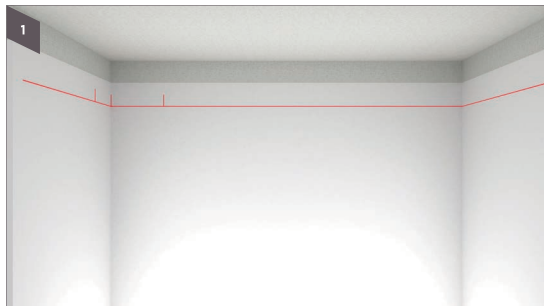

1 Use a laser beam to measure and plan the ceiling installation process where the min distance of Spring tee shall be 300 mm and shall not exceed 450 mm from wall

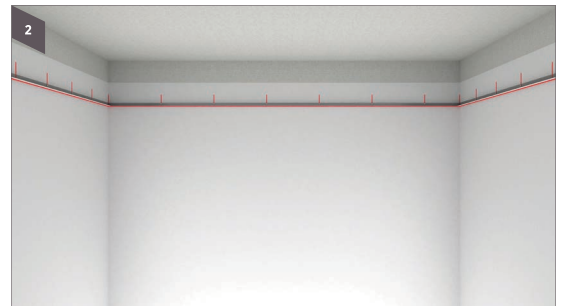

2 Install wall angles around the perimeter at marked locations using screws @450 mm o.c

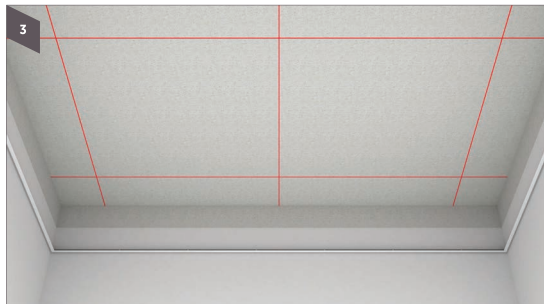

3 Mark with laser the hanger spacing at 1200 mm o.c.

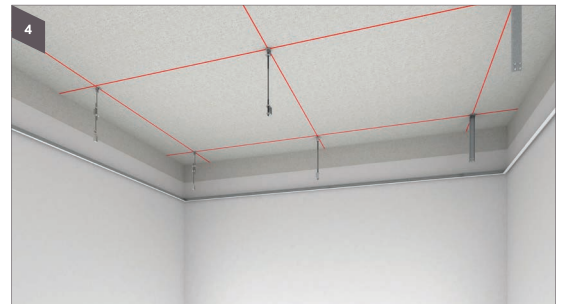

4 Fix hangers at 1200 mm o.c in a gradient scheme above the lines of primary channels



Use the specified hanging system (Adjustable hanger)



Use the specified hanging system (Primary Channel hanger)



Use the specified hanging system (Threaded rod)

LAY-IN



Fix the main tee at 1200 mm spacing and lay it on the wall angle.



Insert the long cross tee to main tee in place for 600x600 module

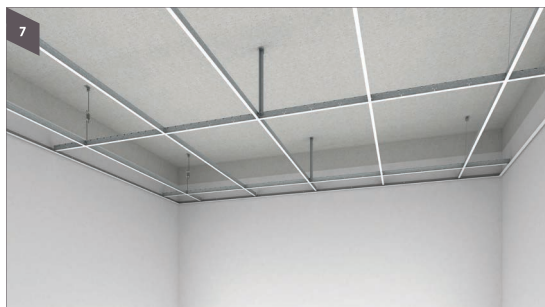

Insert the long cross tee to main tee in place for 600x600 module (Angle View)

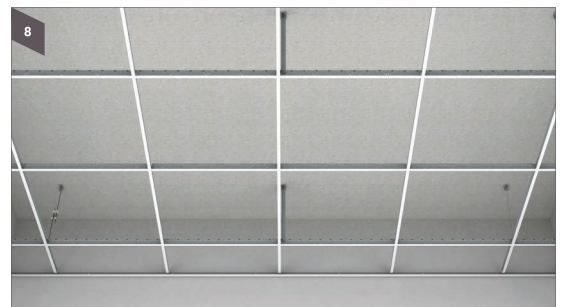

Insert the short cross tee to long tee in place

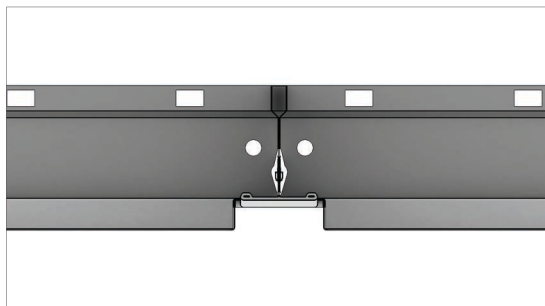

DONN® brand audible click

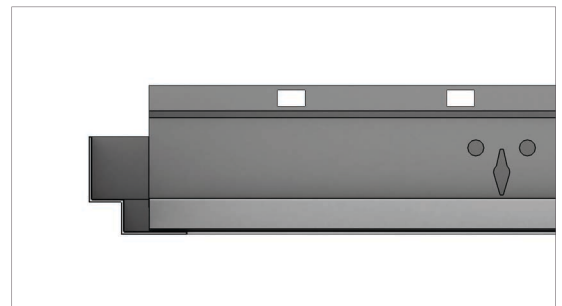

Lay-In-Wall Section Detail





SEE US ON LINKEDIN
/usgboralme



FIND US ON FACEBOOK
/usgboralme



FOLLOW US ON INSTAGRAM
/usgboral_me



FOLLOW US ON TWITTER
/usgboralme



SEE US ON YOUTUBE
/USG Middle East

FACTORY OF USG MIDDLE EAST LTD. CO.

7410 (Wasil), Street #23, Cross 76
2nd Industrial City, Dammam 34326-4201
Kingdom of Saudi Arabia

CUSTOMER SERVICE

t +966 13 812 0995

f +966 13 812 1029

info@usgme.com

www.usgme.com

WEBSITE

www.usgme.com